

Varenummer: 0118015  
 Beskrivelse: Seeger låsering H 5

## Mål

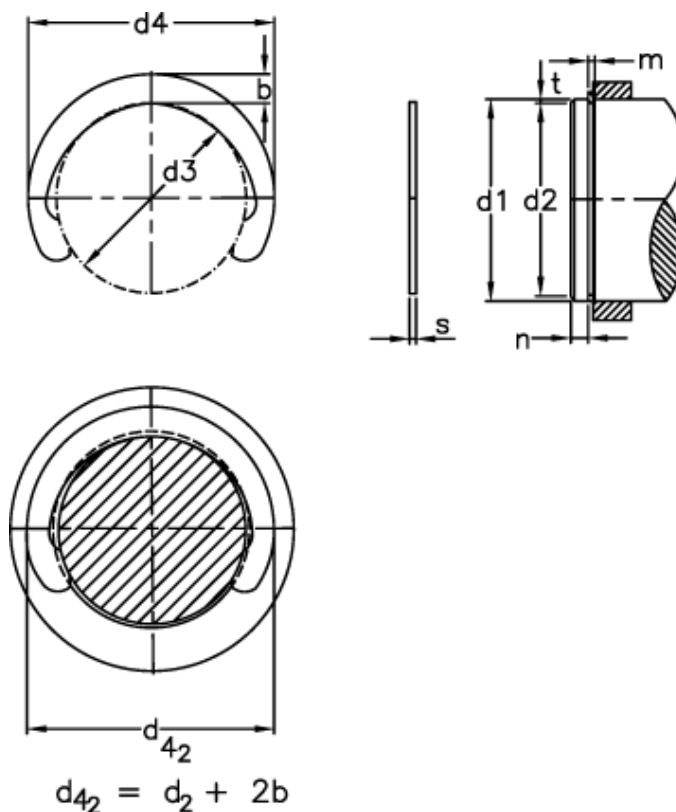

b	= 1.20	FRg kN	= 0.7	t	= 0.50
Betegnelse	= H 5,0	FR kN	= 1.10	tol	= -0.07
d1	= 5	g	= 0.60	tol	= 0.08
d2	= 4.0	Griber	= GRH 5	tol	= -0.05
d3	= 3.80	m min	= 0.64	vægt kg/1000	= 0.08
d4	= 6.20	n abl x 1000	= 88		
d4 2	= 6.4	Nominel træk	= 1.5		
FN kN	= 0.58	s	= 0.60		